

1 MOVING EYES

ムービングアイ 材質 PVC+PS

FLAT



ROUND



OVAL



COLOR 颜色仅供参考，如客户所需颜色特殊可与我们协商。

YELLOW		PINK		RED	
GREEN		BLUE		BLACK	
(UNDER) YELLOW		(UNDER) PINK		(UNDER) RED	

2 MOVING EYES

ムービングアイ 材質 PVC+PS



※N:
NORMAL



L:
LAMINATE



S:
SEW-ON



W:
WAPPEN
(ADHESIVE)



PW:
PLASTIC
WASHER

FLAT						
Item Numb	SIZE	N	L	S	W	PW
ME4 F	4mm	●	●			
ME5 F	5mm	●	●			
ME6 F	6mm	●	●			
ME7 F	7mm	●	●			
ME8 F	8mm	●	●	●	●	
ME9 F	9mm	●	●		●	
ME10 F	10mm	●	●	●	●	●
ME11 F	11mm	●	●		●	
ME12 F	12mm	●	●	●	●	●
ME13 F	13mm	●	●	●	●	
ME14 F	14mm	●	●		●	
ME15 F	15mm	●	●	●	●	●
ME16 F	16mm	●	●		●	
ME17 F	17mm	●	●		●	
ME18 F	18mm	●	●	●	●	●
ME19 F	19mm	●	●		●	
ME20 F	20mm	●	●	●	●	●
ME23 F	23mm	●	●	●	●	●
ME25 F	25mm	●	●	●	●	●
ME28 F	28mm	●	●	●	●	
ME30 F	30mm	●	●	●	●	●
ME35 F	35mm	●	●	●	●	
ME40 F	40mm	●	●	●	●	

SIZE	A	B	N	OV	OV-B	PW	R
3mm	3.5		2.0				1.2
4mm	4.5	2.0	2.5				1.5
5mm	5.5	2.5	2.5				1.5
6mm	6.0	3.5	3.0				1.5
7mm	7.0	4.0	3.0				
8mm	8.0	4.4	3.0				
9mm	9.0	5.5	3.0				
10mm	10.0	6.0	3.0	7.5	5.0	3.7/SW-3	
11mm	11.0	7.0	3.5				
12mm	12.0	8.0	3.5	9.0	6.0	5.2/NPW-0or1	
13mm	13.0	8.5	4.0				
14mm	14.0	9.0	4.0				
15mm	15.0	9.5	4.5	11.0	8.0	6.7/NPW-3	
16mm	16.0	10.0	4.5				
17mm	17.0	10.5	4.5				
18mm	18.0	11.0	5.0	13.5	9.0	6.7/NPW-3	
19mm	19.0	12.0	5.0				
20mm	20.0	13.0	5.5	15.0	10.0	6.7/NPW-4	
23mm	23.0	15.0	6.0			6.7/NPW-4	
25mm	25.0	16.0	6.0			6.7/NPW-4	
28mm	28.0	17.0	6.5				
30mm	30.0	18.5	7.0	26.0	18.0	6.7/PW-5	
35mm	35.0	21.0	8.0				
40mm	40.0	25.0	7.5				

OVAL			
Item Numb	SIZE	N	L
ME10 O	10mm	●	●
ME12 O	12mm	●	●
ME15 O	15mm	●	●
ME18 O	18mm	●	●
ME20 O	20mm	●	●
ME30 O	30mm	●	●

ROUND			
Item Numb	SIZE	N	L
ME3 R	3mm	●	●
ME4 R	4mm	●	●
ME5 R	5mm	●	●
ME6 R	6mm	●	●

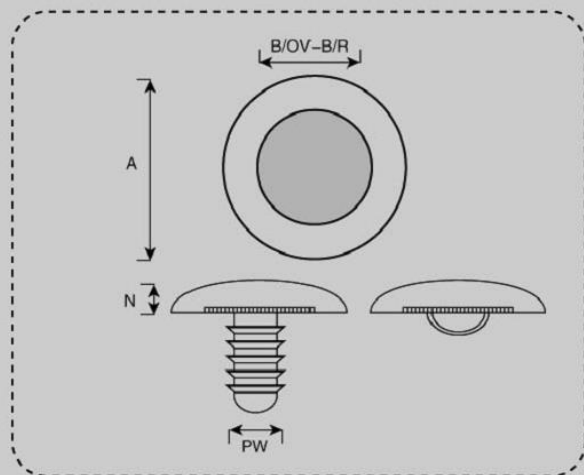

订货说明

例: ME 4 F N
类别 尺寸 外型 背足

3 SOLID EYES

ソリッドアイ 材質 PS

SOLID EYES

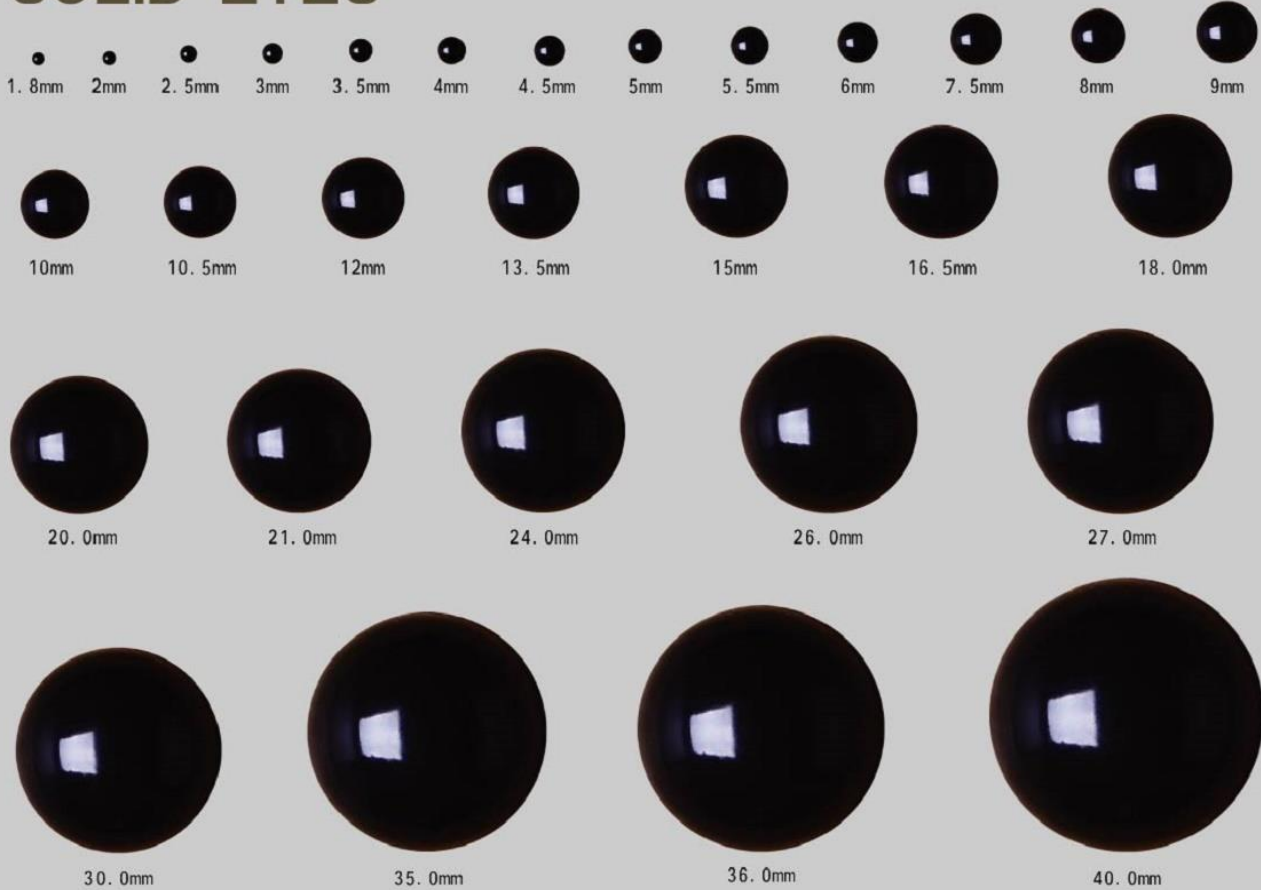

SOLID EYES N

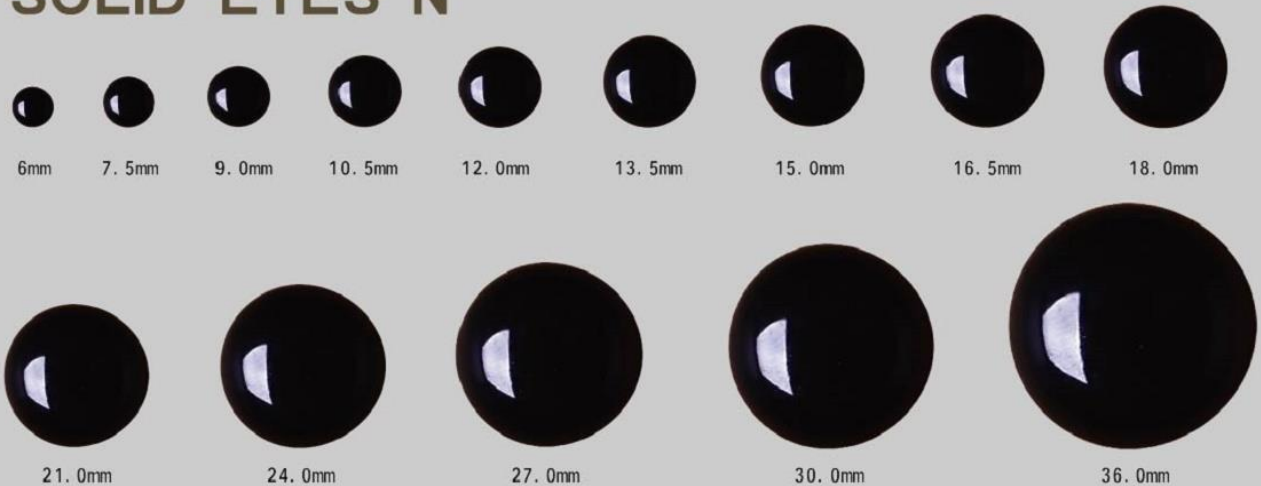

COLORS 颜色说明

颜色仅供参考，如客户所需颜色特殊可与我们协商。



4 SOLID EYES

ソリッドアイ 材質 PS

尺寸图解

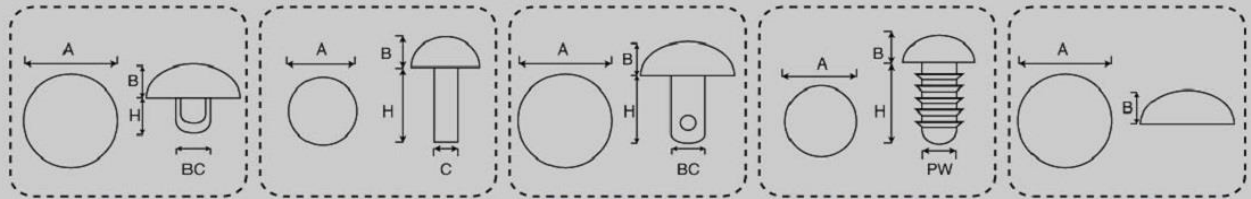

※B: SEW-ON
(扣状足, 缝制适用)

C: STRAIGHT
FOOT
(直腿, 配合垫圈
或融化)

BC: SEW-ON
& STRAIGHT
FOOT
(兼顾B和C与一身)

PW: PLASTIC-
WASHER
(环纹足, 配合垫圈)

NO: NO FOOT
(无脚, 胶粘用)

订货说明

SOLID EYES & SOLID EYES N

例: SOLID S 15 BLACK-P/UNP PW
类别 一次成型 尺寸 颜色-有光/无光 足型

SIZE	C	B	BC	PW	BC-N	PW-N	NO	A	B	B-N	H	C	BC	BC-N	PW/PW-N
1.8mm	●							1.8	1.0		6.0	1.5			
2.0mm	●							2.0	1.0		6.0	1.5/SSW-1			
2.5mm	●							2.5	1.5		5.8	1.5/SSW-1			
3.0mm	●						●	3.0	1.5		6.0	1.5/SSW-1			
3.5mm	●							3.5	2.0		6.0	1.5/SSW-1			
4.0mm	●						●	4.0	2.0		6.0	1.5/SSW-1			
4.5mm	●			●				4.5	2.5		7.5	2.0/MW-0			2.5/SSW-2
5.0mm	●						●	5.0	2.5		7.0	2.0/MW-0			
5.5mm	●							5.5	3.0		7.0	2.0/MW-0			
6.0mm	●			●		●		6.0	3.0	2.0	7.0	2.0/MW-0			3.7/SW-3
7.5mm	●			●		●		7.5	3.0		8.0	2.0/MW-0			3.7/SW-3
8.0mm	●			●				8.0	4.0		10.5	3.5/MW-3.5			5.2/NPW-1
9.0mm	●	●		●		●		9.0	4.0	2.5	12.0	3.5/MW-3.5			5.2/NPW-1
10.0mm	●							10.0	4.5		11.0	3.5/MW-3.5			
10.5mm	●	●		●		●		10.5	4.0	3.0	12.0	3.5/MW-3.5			5.2/NPW-1
12.0mm	●	●		●	●	●		12.0	4.5	3.5	12.0	5.0/MW-5		5.0/MW-5	5.2/NPW-1
13.5mm	●	●		●	●	●		13.5	5.0	4.0	12.0	5.0/MW-5		5.0/MW-5	5.2/NPW-1
15.0mm	●	●	●	●	●	●		15.0	5.5	4.0	14.0	5.0/MW-5	6.5/MW-7	5.0/MW-5	6.7/NPW-3
16.5mm	●	●	●	●	●	●		16.5	6.5	4.0	14.0	5.0/MW-5	6.5/MW-7	5.0/MW-5	6.7/NPW-3
18.0mm	●	●	●	●	●	●		18.0	6.5	5.5	13.0	5.0/MW-5	6.5/MW-7	6.5/MW-7	6.7/NPW-3
20.0mm				●											
21.0mm	●	●	●	●	●	●		21.0	8.0	5.5	13.0	5.0/MW-5	6.5/MW-7	6.5/MW-7	6.7/NPW-4
24.0mm	●	●	●	●	●	●		24.0	9.0	6.0	13.0	5.0/MW-5	8.5/MW-8	6.5/MW-7	6.7/NPW-4
26.0mm				●											
27.0mm				●	●			27.0	9.0	6.0	13.0		8.5/MW-8	6.5/MW-7	
30.0mm	●			●	●			30.0	9.5	6.5	13.0	6.5/MW-7	8.5/MW-8	6.5/MW-7	6.5/PW-5
35.0mm				●											
36.0mm				●	●			36.0	13.0	7.0	15.0		8.5/MW-8	6.5/MW-7	
40.0mm				●				40.0	9.5		12.5				6.5/PW-5

BUTTON

ボタン 材質 PS / PC

HALF ROUND 材質: PS



SIZE	A	N	H	R
4mm	4.0	2.0	1.5	1.0
5mm	5.0	2.5	1.5	1.2
6mm	6.0	3.0	2.5	2.0
8mm	8.0	4.0	3.0	2.0
10mm	9.5	4.7	3.0	2.0

SNAP 材質: PC



male



female

5 CRYSTAL EYES

クリスタルアイ 材質 PS

	C	PW	A	B	C	PW	N	H
4.5	●		4.5	2.5	2.0/MW-0		2.0	7.0
6.0	●	●	6.0	3.0	2.0/MW-0	3.7/SW-3	2.5	8.0
7.5	●		7.5	3.8	2.5/MW-1		3.0	8.0
8.0		●	8.0	4.0		5.0/NPW-1	4.0	12.0
9.0	●		9.0	4.5	3.5/MW-3.5		4.0	12.0
10.0		●	10.0	5.0		5.0/NPW-1	4.0	13.0
10.5	●		10.5	5.5	5.0/MW-5		4.0	12.0
12.0	●	●	12.0	6.0	5.0/MW-5	5.0/NPW-1	4.5	13.0
13.5	●	●	13.5	6.8	5.0/MW-5	5.0/NPW-2	5.5	13.0
15.0	●	●	15.0	7.5	5.0/MW-5	6.5/NPW-3	6.0	12.5
16.5	●	●	16.5	8.5	5.0/MW-5	6.5/NPW-3	6.5	12.5
18.0	●	●	18.0	9.0	5.0/MW-5	6.5/NPW-4	7.0	12.5
20.0		●	20.0	10.0		6.5/NPW-4	7.5	12.5
21.0	●		21.0	10.5	5.0/MW-5		8.0	12.5
24.0	●	●	24.0	12.0	5.0/MW-5	6.5/NPW-4	9.0	12.5
30.0		●	30.0	15.0		6.5/NPW-5	10.5	12.5

三色眼

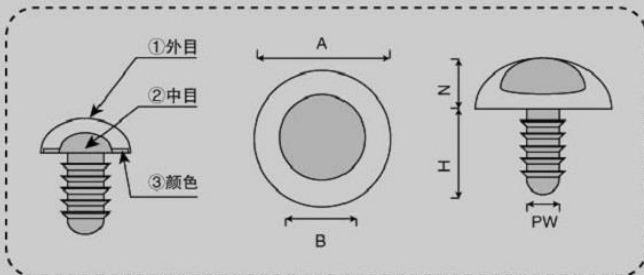

注：由于外目是透明半球体所以中目尺寸视觉上会比实际尺寸略大！

COLOR 通常色



订货说明

例：CRYSTAL T 15 BROWN PW
产品类别 三次成型 尺寸 颜色 足型

COLOR 荧光色

颜色仅供参考，如客户所需颜色特殊可与我们协商。



6 CRYSTAL EYES

クリスタルアイ 材質 PS

二色眼

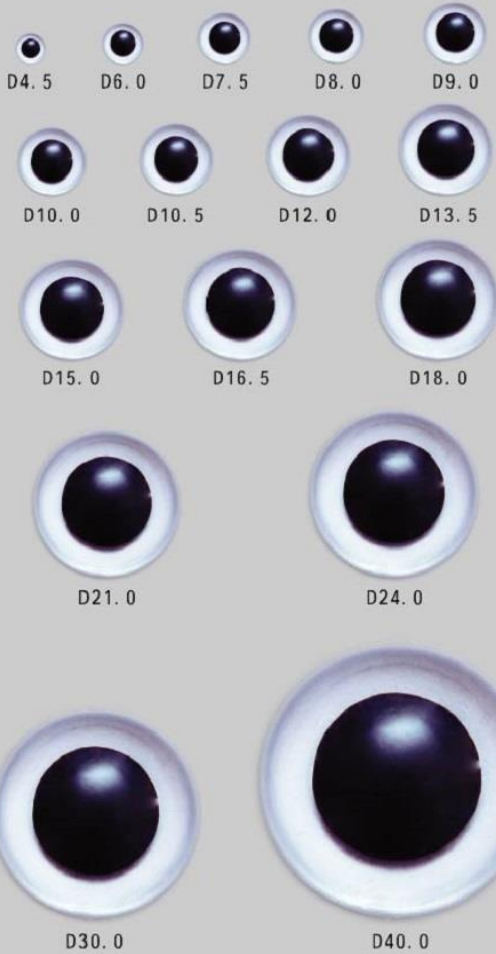

	B	C	PW	A	B	C	PW	N	H
4.5		●		4.5	3.0	2.0/MW-0		2.0	7.0
6.0		●		6.0	4.0	2.0/MW-0		2.5	8.0
7.5		●		7.5	5.0	2.5/MW-1		3.0	8.0
9.0	●	●		9.0	6.0	3.5/MW-3.5		4.0	12.0
10.0			●	10.0	7.0		5.0/NPW-1	4.0	12.0
10.5	●	●		10.5	6.5	3.5/MW-3.5		4.0	12.0
12.0	●	●	●	12.0	7.5	5.0/MW-5	5.0/NPW-1	4.5	13.0
13.5	●	●	●	13.5	8.5	5.0/MW-5	5.0/NPW-2	5.0	13.0
15.0	●	●	●	15.0	9.5	5.0/MW-5	6.5/NPW-3	5.8	12.5
16.5	●	●	●	16.5	11.5	5.0/MW-5	6.5/NPW-3	6.5	12.5
18.0	●	●	●	18.0	11.0	5.0/MW-5	6.5/NPW-4	7.0	12.5
21.0	●	●		21.0	13.0	5.0/MW-5		8.0	13.0
24.0	●	●		24.0	14.5	5.0/MW-5		9.0	13.0
30.0		●		30.0	19.0	6.5/MW-7		10.0	17.0
40.0			●	40.0	20.0		6.5/PW-5	12.5	14.0

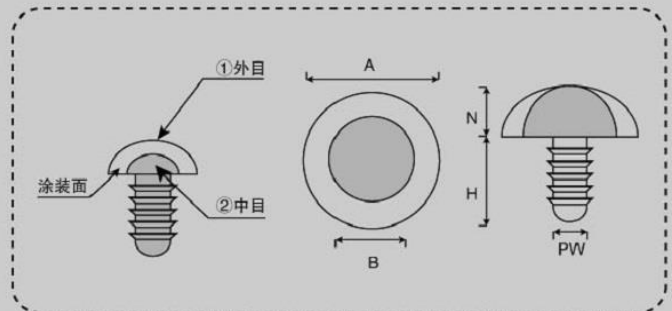

注：由于外目是透明半球体所以中目尺寸视觉上会比实际尺寸略大！

订货说明

例：CRYSTAL D 15 BROWN PW
 产品类别 二次成型 尺寸 颜色 足型

CAT EYE 猫眼



CAT D	C	PW	A	B	D	C	PW	N	H
7.5	●		7.5	5.0	3.5	2.5/MW-1		3.0	8.0
9.0	●	●	9.0	7.0	4.5	2.5/MW-1	3.5/SW3.5	4.0	8.0
10.5	●		10.5	8.0	5.5	3.5/MW-3.5		4.0	8.0
12.0	●	●	12.0	9.0	5.5	3.5/MW-3.5	5.0/NPW-1	4.5	8.0
13.5	●	●	13.5	9.5	6.0	3.5/MW-3.5	5.0NPW-1or2	5.0	12.0
15.0	●		15.0	10.0	7.0	5.0/MW-5		5.7	12.0
16.5	●		16.5	12.0	7.5	5.0/MW-5		6.5	12.0
18.0	●		18.0	12.5	7.5	5.0/MW-5		7.0	12.0
21.0	●		21.0	14.0	8.5	5.0/MW-5		8.0	12.0
24.0	●		24.0	17.0	11.0	6.5/MW-7		9.0	14.0

猫眼颜色可参考下页透明色和珠光色

7 CRYSTAL EYES

クリスタルアイ 材質 PS

大眼仁



60%	A	B	PW	N	H
6.0	6.0	3.6	3.5/APW-7B	2.0	11.5
8.0	8.0	4.8	5.0/NPW-1	2.5	12.0
10.0	10.0	6.0	5.0/NPW-1	3.0	12.0
12.0	12.0	7.2	5.0/NPW-1	4.0	12.0
13.5	13.5	8.1	5.0/NPW-1	4.3	12.0
15.0	15.0	9.0	6.5/NPW-3	4.6	12.0
16.5	16.5	9.9	6.5/NPW-3	5.0	12.0
18.0	18.0	10.8	6.5/NPW-3	5.5	12.5
20.0	20.0	12.0	6.5/NPW-4	6.3	12.5
24.0	24.0	14.4	6.5/NPW-4	7.8	12.5
30.0	30.0	18.0	6.5/PW-5	9.5	12.5
35.0	35.0	21.0	6.5/PW-5	9.5	12.5
40.0	40.0	24.0	6.5/PW-5	9.5	12.5

55%	A	B	PW	N	H
10.0	10.0	5.5	5.0/NPW-1	3.0	12.0
12.0	12.0	6.5	5.0/NPW-1	4.0	12.0
13.5	13.5	7.5	5.0/NPW-1	4.3	12.0
16.5	16.5	9.1	6.5/NPW-3	5.0	12.0
20.0	20.0	11.0	6.5/NPW-4	6.3	12.5
26.0	26.0	14.3	6.3/NPW-4	9.0	12.5
30.0	30.0	16.5	6.5/PW-5	9.5	12.5

55%和60%的意思是眼仁部分占眼睛的比例

COLOR 透明色

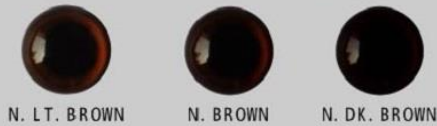

COLOR 珠光色



颜色仅供参考，如客户所需颜色特殊可与我们协商。

8 LASER SIGHT

レーザーサイト 材質 PMMA



中目 (mm)

外目 (mm) \ 中目 (mm)	1.5	1.75	2.0	2.25	2.4	2.5	2.6	3.0	3.25	3.5	4.0
3.0	◎										
3.5	○	◎									
4.0	○	○	◎								
4.5	○	○	○	◎							
4.8	○	○	○	○	◎						
5.0	○	○	○	○	○	◎					
5.2	○	○	○	○	○	○	◎				
6.0	○	○	○	○	○	○	○	◎			
6.5									◎		
7.0									○	◎	
8.0											◎

镭射眼的颜色多样，可参考透明色和珠光色或客户指定颜色！

COMICAL EYES

コミカルアイ 材質 PS+PVC

FROG EYES 蛙眼



FM 16-C



FM 24-C



FM 36-C



FM 48-C

9 COMICAL EYES

コミカルアイ 材質 PS

AC

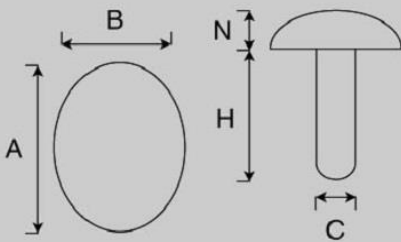

ACS	A	B	C	N	H
3.5	3.5	2.5	1.5/-	1.0	5.5
4.0	4.0	2.8	2.0/MW-0	1.0	7.0
4.5	4.5	3.5	2.0/MW-0	1.4	7.0
6.5	6.5	5.0	2.0/MW-0	1.7	8.0
8.0	8.0	6.0	2.5/MW-1	2.0	8.0
10.0	10.2	8.0	3.5/MW-3.5	1.9	8.0
13.0	13.5	10.4	3.5/MW-3.5	3.0	11.0
15.0	15.5	12.0	3.5/MW-3.5	3.5	12.0
17.0	18.0	13.5	5/MW-5	4.0	12.0
20.0	20.0	14.0	5/MW-5	4.3	12.0
25.0	25.0	16.5	6.5/MW-7	5.0	14.5
30.0	29.5	20.0	6.5/MW-7	6.0	12.5
38.0	38.0	25.0	6.5/MW-7	7.5	12.5
40.0	40.0	26.5	6.5/MW-7	8.0	12.5

ANC S	A	B	C	N	H
90.0	90.0	59.5	8.5/MW-8	9.5	14.5
99.0	99.0	50.0	8.5/MW-8	10.0	27.0

订货说明

例: AC S 15 BROWN C
 产品类别 一次成型 尺寸 颜色 足型

ANC



CNC

CNC S	A	B	C	N	H
64.0	56.0	42.5	8.5/mn-8	5.0	14.5



10 COMICAL EYES

コミカルアイ 材質 PS

AP



AP S4.5 AP S5.5 AP S6.5 AP S8 AP S10 AP S12 AP S13



AP S15 AP S17 AP S20 AP S25 AP S30

ANP



ANP S8 ANP S10 ANP S11 ANP S12 ANP S13 ANP S14 ANP S15



ANP S16 ANP S17 ANP S18 ANP S19 ANP S20 ANP S22

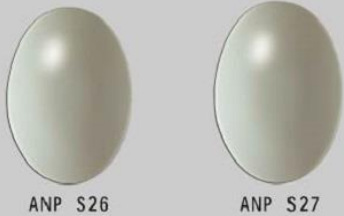

ANP S26 ANP S27

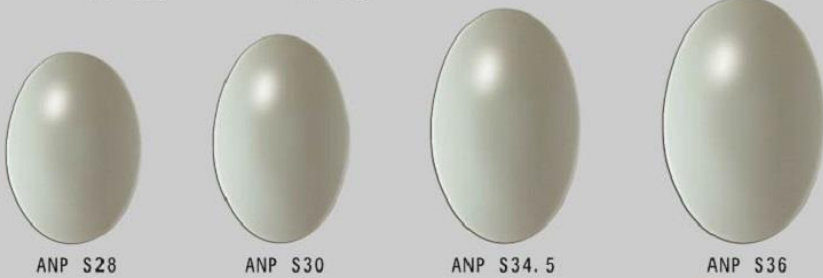

ANP S28 ANP S30 ANP S34.5 ANP S36

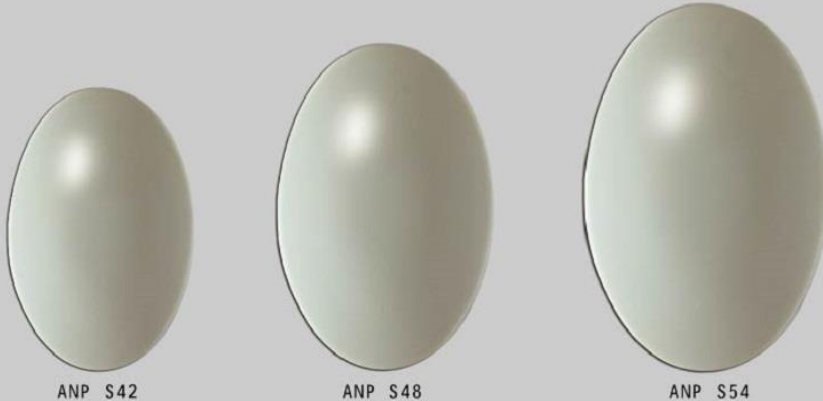

ANP S42 ANP S48 ANP S54

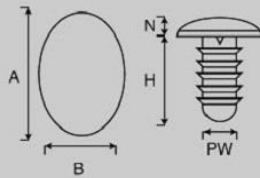

AP S	A	B	PW	N	H
4.5	4.5	3.5	2.5/SSW-2	1.4	7.5
5.5	5.5	4.0	2.5/SSW-2	1.5	7.5
6.5	6.5	5.0	3.5/SW-3	1.7	11.3
8.0	8.0	6.0	5.2/NPW-1	2.0	13.3
10.0	10.2	8.0	5.2/NPW-1	1.9	13.3
12.0	12.5	9.5	5.2/NPW-1	3.0	13.3
13.0	13.5	10.4	5.2/NPW-1	3.0	13.3
15.0	15.5	12.0	5.2/NPW-1	3.5	13.3
17.0	18.0	13.5	5.2/NPW-2	4.0	13.3
20.0	20.0	14.0	6.7/NPW-3	4.3	14.0
25.0	25.0	16.5	6.7/NPW-4	5.0	14.0
30.0	29.5	20.0	6.7/NPW-4	6.0	14.0

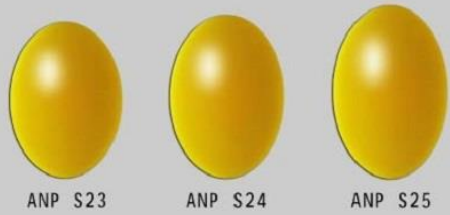

ANP S23 ANP S24 ANP S25

ANP S	A	B	PW	N	H
8.0	8.0	6.0	3.5/SW-3	1.5	11.3
10.0	10.0	8.0	3.5/SW-3	1.5	11.3
11.0	11.0	8.0	5.0/NPW-1	1.5	13.3
12.0	12.5	9.5	5.0/NPW-1	1.6	13.3
13.0	13.0	9.0	5.0/NPW-1	1.8	13.3
14.0	14.0	10.0	5.0/NPW-1	2.0	13.3
15.0	15.0	10.5	5.0/NPW-1	2.0	13.3
16.0	16.0	11.5	5.0/NPW-1	2.0	13.3
17.0	17.0	12.0	5.0/NPW-1or2	2.0	13.3
18.0	18.0	12.5	5.0/NPW-1or2	2.5	13.3
19.0	19.0	13.5	5.0/NPW-1or2	2.5	13.3
20.0	20.0	14.0	6.7/NPW-3	3.0	14.0
22.0	22.0	15.5	6.5/NPW-3	3.0	14.0
23.0	23.0	16.5	6.5/NPW-3	3.0	14.0
24.0	24.0	17.0	6.5/NPW-3	3.0	14.0
25.0	25.5	17.0	6.7/NPW-3or4	3.0	14.0
26.0	26.0	18.5	6.5/NPW-3or4	3.0	14.0
27.0	27.0	19.0	6.5/NPW-3or4	3.0	14.0
28.0	28.0	20.0	6.5/NPW-3or4	3.0	14.0
30.0	30.5	20.0	6.7/NPW-4	3.0	14.0
34.5	34.5	22.0	6.5/NPW-4	3.0	14.0
36.0	36.5	24.0	6.5/NPW-4	3.0	14.0
42.0	42.0	28.0	6.5/NPW-4	3.5	14.0
48.0	48.0	32.0	6.5/PW-5	4.0	14.0
54.0	54.0	36.0	8.5/PW-6	6.0	15.5
60.0	60.0	42.0	8.5/PW-6	6.0	15.5
64.0	64.0	42.5	8.5/PW-6	6.0	15.5
75.0	75.0	49.0	8.5/PW-6	6.0	15.5
82.0	81.5	54.0	8.5/PW-6	6.0	15.5

11 COMICAL EYES

コミカルアイ 材質 PS

ANP



ANSP

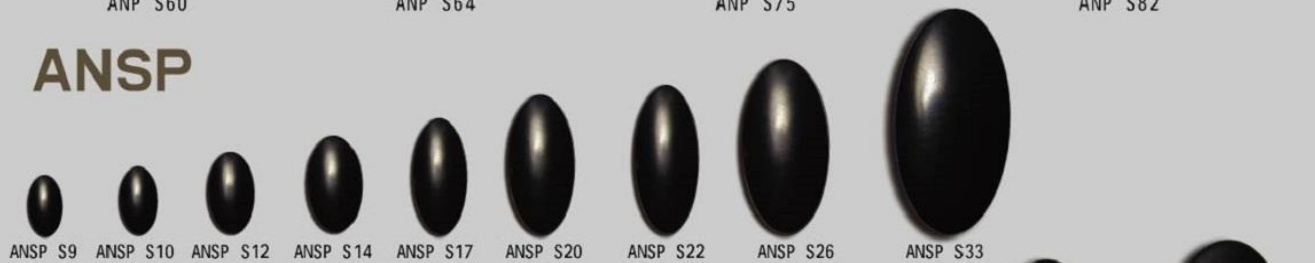

ANSP S	A	B	PW	N	H
9.0	9.0	5.0	3.5/SW-3	1.0	11.0
10.0	10.0	5.5	3.5/SW-3	1.5	10.0
12.0	12.0	6.5	5.0/NPW-0or1	1.6	13.5
14.0	14.0	8.0	5.0/NPW-0or1	2.0	13.5
17.0	17.0	8.0	5.0/NPW-0or1	2.0	12.0
20.0	20.5	10.0	6.5/NPW-3	3.0	13.5
22.0	22.0	9.5	6.5/NPW-3	2.0	13.5
26.0	26.0	13.0	6.5/NPW-3	3.0	13.5
33.0	33.0	17.0	6.5/NPW-3or4	3.5	13.5
37.0	37.0	16.5	6.5/NPW-4	3.5	13.5
38.0	38.0	18.0	6.5/NPW-4	4.0	13.5
41.5	41.5	21.0	6.5/PW-5	4.0	13.5
45.0	45.0	20.0	6.5/PW-5	4.0	13.5
48.0	48.0	22.0	6.5/PW-5	3.5	13.5
53.5	53.5	23.0	6.5/PW-5	3.0	12.5
53.5-B	53.5	23.0	6.5/PW-5	4.5	13.5
65.0	65.0	28.0	8.5/PW6	3.5	16.5
68.0	68.0	34.0	6.5/NPW-3*2	5.0	12.5

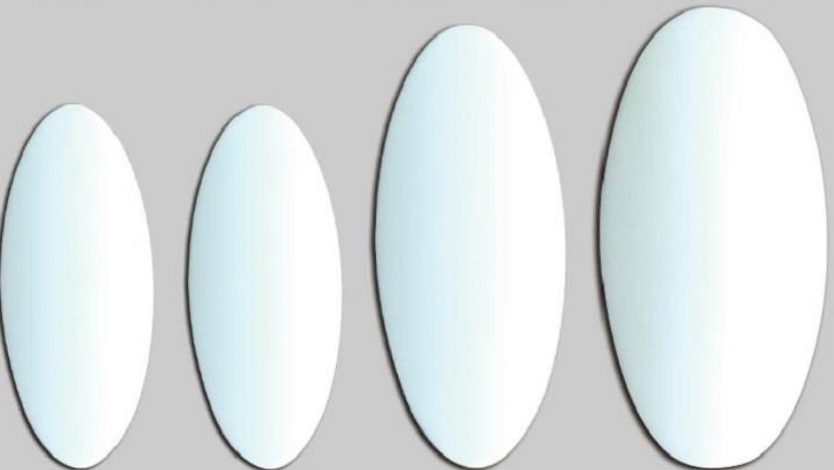
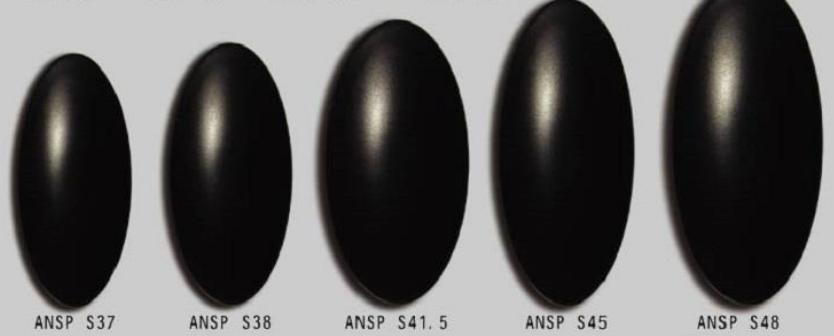

ANP: 长 (A) 宽 (B) 比为: 1: 80%~63% ANSP: 长 (A) 宽 (B) 比为: 1:53%~43%

12 COMICAL EYES

コミカルアイ 材質 PS

ANMP



ANMP S22



ANMP S30



ANMP S53



ANMP S65

ANMP S	A	B	PW	N	H
22.0	22.0	13.5	6.5/NPW-3	2.0	14.0
30.0	30.0	17.5	3.0/NPW-3or4	3.0	13.5
53.0	53.5	29.0	8.5/PW-6	6.0	15.5
65.0	65.0	37.5	8.5/PW-6	6.0	15.5

ANMP:长 (A) 宽 (B) 比例: 1:62%~54%

ANSSP:长 (A) 宽 (B) 比例: 1:43%~30%

ANSSP S	A	B	PW	N	H
15.0	15.0	6.0	5.0/NPW-0or1	2.0	13.3
20.5	20.5	8.5	6.5/NPW-3	2.0	14.0
26.0	26.0	11.0	6.5/NPW-3	2.5	13.5
40.0	40.0	17.0	6.5/PW-5	3.0	13.5
71.0	71.0	30.0	8.5/PW-6	6.0	15.5
99.0	99.0	41.0	8.5/PW-6	4.0	15.5
123.0	122.5	52.0	8.5/PW-6	5.0	15.5

ANSSP



ANSSP S15



ANSSP S20.5



ANSSP S26



ANSSP S40

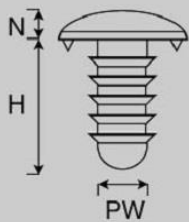
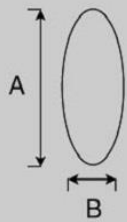

ANSSP S71



ANSSP S99



ANSSP S123

AHP



AHP S10

AHP S	A	B	PW	N	H
10.0	10.0	8.0	5.2/NPW-1	4.0	13.5

13 COMICAL EYES

コミカルアイ 材質 PS

BP



BP S15



BP S25



BP S30

BNP



BNP S15



BNP S16



BNP S18



BNP S19



BNP S20



BNP S22



BNP S24



BNP S25



BNP S28



BNP S30



BNP S36



BNP S42



BNP S48

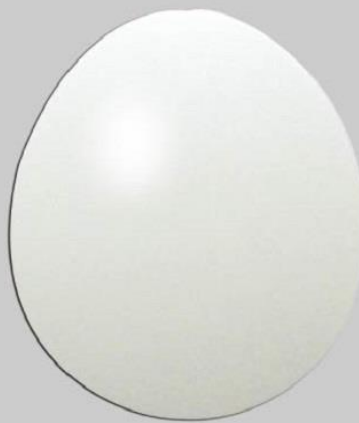

BNP S60

CNP



CNP S10



CNP S20



CNP S28



CNP S38

WNP



WNP S15



WNP S23



WNP S30



WNP S23B

BP S	A	B	PW	N	H
15.0	15.0	12.0	5.0/NPW-1	3.0	12.0
25.0	25.0	20.5	6.5/NPW-3or4	4.0	13.5
30.0	30.5	24.5	6.5/NPW-3or4	5.5	14.0

BNP S	A	B	PW	N	H
15.0	15.0	12.0	5.0/NPW-1	3.0	13.3
16.0	16.0	13.5	5.0/NPW-1	3.0	13.3
18.0	18.5	15.5	5.2/NPW-2	3.0	13.3
19.0	19.0	15.0	6.5/NPW-3	3.0	14.0
20.0	20.5	16.5	6.5/NPW-3	3.0	14.0
22.0	22.0	18.0	6.5/NPW-3	3.0	14.0
24.0	24.0	19.5	6.5/NPW-3	3.0	14.0
25.0	25.5	21.0	6.7/NPW-3or4	4.0	14.0
28.0	28.0	23.0	6.5/NPW-3or4	4.0	14.0
30.0	30.5	25.0	6.5/NPW-3or4	3.0	14.0
36.0	36.0	30.0	6.5/NPW-4	3.0	14.0
42.0	42.0	35.0	6.5/NPW-4	4.0	14.0
48.0	48.0	40.0	6.5/PW-5	4.0	14.0
60.0	60.0	52.0	8.5/PW-6	5.0	15.5

CNP S	A	B	PW	N	H
10.0	9.0	6.0	5.2/NPW-1	1.7	12.0
26.0	19.0	26.0	6.5/NPW-3or4	3.0	14.0
30.0	30.0	27.0	6.5/NPW-4	4.5	14.0
38.0	34.0	25.0	6.5/NPW-4	4.0	14.0

WNP S	A	B	PW	N	H
15.0	15.0	8.5	5.0/NPW-1	1.5	13
23.0	23.0	13.0	6.5/NPW-3	2.6	14.0
30.0	31.0	18.0	6.5/NPW-4	3.5	14.0
23B	23.0	18.0	6.5/NPW-3	3.0	14.0

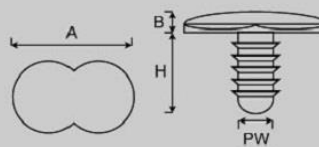

14 COMICAL EYES

コミカルアイ 材質 PS

RNP



RNP S10 RNP S11 RNP S12 RNP S13 RNP S14 RNP S15



RNP S16 RNP S18 RNP S20 RNP S23



RNP S25 RNP S30 RNP S36



RNP S40 RNP S48 RNP S50

RNP S	A	PW	N	H	R
20.0/2	20	6.7/NPW-3	2.5	14.0	2.0
23.0/2	23	6.7/NPW-3	2.5	14.0	2.0



RNP S20/2 RNP S23/2

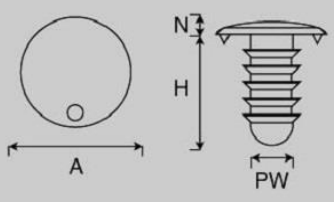

RNP S60



RNP S70

RNP S	A	PW	N	H
10.0	10.0	3.5/SW-3	2.0	11.3
11.0	11.0	5.0/NPW-1	2.0	13.3
12.0	12.0	5.0/NPW-1	2.5	13.3
13.0	13.0	5.0/NPW-1	2.5	13.3
14.0	14.0	5.0/NPW-1	2.5	13.3
15.0	15.0	5.0/NPW-1	3.0	13.3
16.0	16.0	5.2/NPW-1	2.5	13.3
18.0	18.0	5.2/NPW-2	2.5	13.3
20.0	20.0	6.7/NPW-3	2.5	14.0
23.0	23.0	6.7/NPW-4	2.5	14.0
25.0	25.0	6.7/NPW-4	4.0	14.0
30.0	30.0	6.5/NPW-4	3.5	14.0
36.0	36.0	6.5/PW-5	4.0	14.0
40.0	40.0	6.5/PW-5	4.0	14.0
48.0	48.0	8.5/PW-6	5.0	15.5
50.0	50.0	8.5/PW-6	5.0	15.5
60.0	60.0	8.5/PW-6	6.0	15.5
70.0				

15 COMICAL EYES

コミカルアイ 材質 PS

ANRP



ANRP D20



ANRP D25



ANRP D30



ANRP D36



ANRP D42



ANRP D45



ANRP D48



ANRP D53



ANRP D54



ANRP D60



ANRP D78



ANRP D64



ANRP D65



ANRP D68



ANRP D75

ANRP D	A	B	PW	N	H
20.0	20.5	14.0	6.5/NPW-3	3.0	14.0
25.0	25.0	17.0	6.5/NPW-3or4	3.0	14.0
30.0	30.0	20.5	6.5/NPW-3or4	3.5	14.0
36.0	36.5	24.5	6.5/NPW-4	3.5	14.0
42.0	42.0	28.0	6.5/NPW-4	3.5	14.0
45.0	45.0	29.0	6.5/NPW-4or5	4.0	14.0
48.0	48.5	32.5	6.5/NPW-4or5	4.0	14.0
53.0	53.5	29.0	8.5/PW-6	5.0	15.5
54.0	54.0	36.0	8.5/PW-6	6.0	15.5
60.0	60.5	37.0	8.5/PW-6	6.5	15.5
64.0	64.0	43.0	8.5/PW-6	5.0	15.5
65.0	65.0	37.5	8.5/PW-6	6.0	15.5
68.0	68.0	45.0	8.5/PW-6	6.0	15.5
75.0	75.0	49.0	8.5/PW-6	6.0	15.5
78.0	78.0	43.0	8.5/PW-6	8.0	15.5

16 COMICAL EYES

コミカルアイ 材質 PS

ANRSP

ANRSP D	A	B	PW	N	H
65.0	65.0	28.0	8.5/PW-6	3.5	15.0



ANRSP D65

DRP



DRP D36

DRP D	A	B	PW	N	H
36.0	36.0	26.0	6.5/NPW-3or4	5.5	12.8

ARC



ARC D20



ARC D30



ARC D38

ARC D	A	B	C	N	H
20.0	20.5	14.0	5.0/MW-5	4.5	12.0
30.0	29.5	20.0	6.5/MW-7	6.0	12.0
38.0	38.0	25.0	6.5/MW-7	7.5	12.0

BNRP



BNRP D18



BNRP D20



BNRP D25



BNRP D30



BNRP D36



BNRP D42

BNRP D	A	B	PW	N	H
18.0	18.5	15.5	6.5/NPW-3	3.0	14.0
20.0	20.5	16.5	6.5/NPW-3	3.0	14.0
25.0	25.5	21.0	6.5/NPW-3or4	4.0	14.0
30.0	30.5	25.0	6.5/NPW-3or4	3.0	14.0
36.0	36.0	30.0	6.5/NPW-4	3.0	14.0
42.0	42.0	35.0	6.5/NPW-4	4.0	14.0

PONCHI



7.5/1-C

7.5/2-PWN

7.5/1-C

7.5/2-PWN

9/1-C

9/2-C



10.5/1-PWN

10.5/2-PWN

12/1-PWN

12/2-PWN



16.5/1-PWN

16.5/2-PWN

21/1-PWN



21/2-PWN

24/1-PWN

24/2-PWN



ANPD18/268

ANRP20/268

ANRSP25/101匹

ANRSP30/101匹

ANRP D36/250

17 COMICAL EYES

コミカルアイ 材質 PS

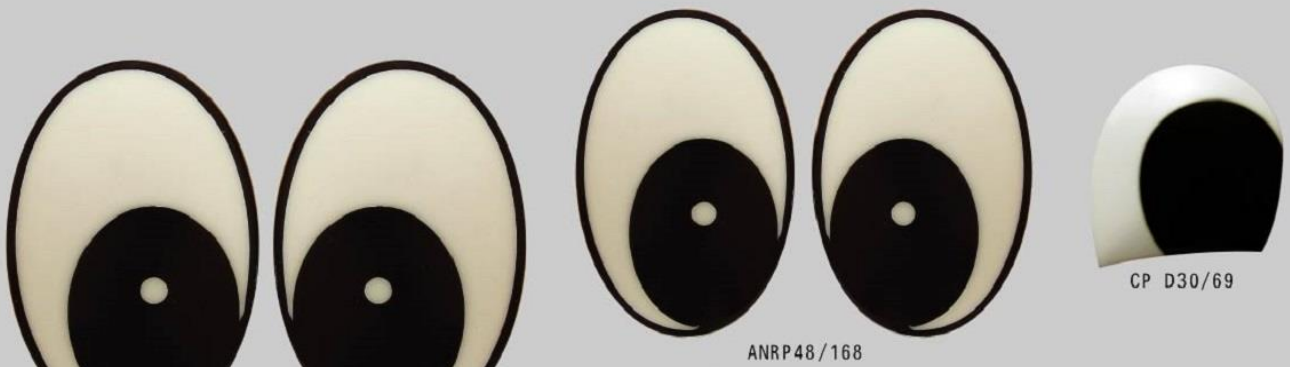

19 NOSE

ハナ 材質 PS

A-NOSES

A-NOSE S	C	BC	PW	A	B	H	C	BC	PW	N
8.0	●		●	8.0	3.0	9.5	3.5/MW-1		3.7/SW-3	3.0
10.0	●			10.0	4.0	9.5	3.5/MW-1			4.0
12.0		●	●	12.0	4.5	12.0		5.0/MW-5	5.0/NPW-1	4.5
15.0		●	●	15.0	6.0	12.0		5.0/MW-5	6.7/NPW-3or4	5.5
18.0		●	●	18.0	7.0	12.0		5.0/MW-5	6.7/NPW-3or4	7.5
20.0		●	●	20.0	8.0	12.0		5.0/MW-5	6.5/NPW-3or4	8.0
23.0		●		23.0	8.0	12.0		5.0/MW-5		8.0
25.0		●		25.0	10.0	12.0		5.0/MW-5		9.0
30.0		●		30.0	12.0	14.0		5.0/MW-7		12.2

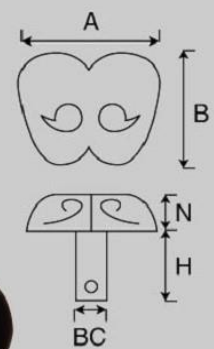
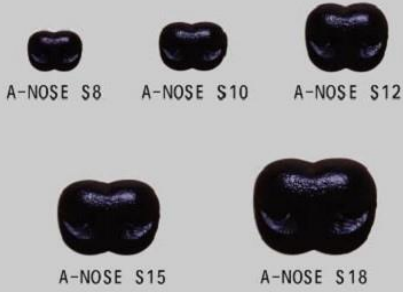

B-NOSE



BN-NOSE



BN-NOSE S	A	B	H	BC	N
13.5	13.5	13.5	12.0	5.0/MW-5	6.0
16.5	16.5	16.5	14.0	5.0/MW-5	6.0

B-NOSE S	A	B	H	BC	N
10.5	10.5	10.5	12.0	5.0/MW-5	4.5
12.0	12.0	12.0	12.0	5.0/MW-5	5.0
13.5	13.5	13.5	12.0	5.0/MW-5	6.0
15.0	15.0	15.0	12.0	5.0/MW-5	6.0
18.0	18.0	18.0	12.0	5.0/MW-5	7.0
21.0	21.0	21.0	12.0	5.0/MW-5	8.5

鼻子颜色可参考单色眼颜色，如客户所需颜色特殊可与我们协商。

CF-NOSE



CF-NOSE S	A	B	C	H	BC	N
20.0	20.0	13.0	10.0	12.5	6.5/MW-7	10.0
25.0	25.0	16.0	12.5	12.5	6.5/MW-7	12.5
30.0	30.0	19.5	15.0	12.5	6.5/MW-7	15.0
40.0	40.0	26.0	26.0	12.5	6.5/MW-7	19.5

订货说明

例: A-NOSE S 15 BLACK BC
 产品类别 一次成型 尺寸 颜色 足型

20 NOSE

ハナ 材質 PS

D-NOSES NORMAL



D-NOSES SAND

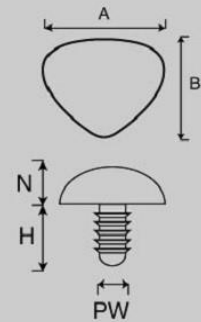

D-NOSES SIBO



订货说明

例: D-NOSE D 15 LT.PINK PW
 产品类别 二次成型 尺寸 颜色 足型

D-NOSES SOFT 材质: PS+ELASTOMER



SAND: 表面 磨砂
 SIBO: 表面 褶皱
 SOFT: 表面 柔软

D-NOSE	C		BC	PW				PWB		A	B	N	H	C/BC	PW/PWB
	NORMAL	SAND	SAND	NORMAL	SAND	SIBO	SOFT	NORMAL	SAND						
4.5	●			●						4.5	3.5	2.0	7.5	2.0/MW-0	2.5/SSW-2
6.0				●						6.0	4.0	2.0	10.0		3.7SW-3
9.0		●		●						9.0	6.2	3.0	10.0	3.5/MW-1	3.7/SW-3
10.5								●		10.5		4.0	12.0		5.2/NPW-1
12.0			●				●	●		12.0	9.0	4.0	12.0		5.2/NPW-1
15.0	●						●	●	●	15.0	11.0	5.2	12.0	5.0/MW-5	5.0/NPW-1
18.0	●					●	●		●	18.0	13.0	6.0	12.0	5.0/MW-5	5.2/NPW-2
21.0	●				●		●			21.0	16.0	8.0	14.0	5.0/MW-5	6.7/NPW-3
22.0						●	●			22.0	16.0	8.0	14.0		6.7/NPW-3
24.0	●						●		●	24.0	19.0	8.0	14.0	5.0/MW-5	6.5/NPW-3
25.0						●				25.0	19.0	8.0	14.0		6.5/NPW-3
28.0	●									28.0	22.0	9.5	14.0	7.0/MW-7	
32.0	●									32.0	26.0	10.0	17.0	7.0/MW-7	
36.0	●									36.0	28.0	12.0	17.0	7.0/MW-7	
38.0				●						38.0	32.0	10.0	14.0		6.5/PW-5

21 NOSE

ハナ 材質 PS

DN-NOSES



DN-NOSE S17



DN-NOSE S21

DN-NOSE S	A	B	N	H	PW
17.0	17.0	13.0	4.0	12.0	5.2/NPW-1
21.0	21.0	16.0	4.5	14.0	6.7/NPW-3

DF-NOSES

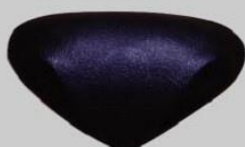

DF-NOSE S35



DF-NOSE S45

DF-NOSE S	A	B	N	H	C
35.0	35.0	20.0	7.0	12.0	5.0/MW-5
45.0	45.0	26.0	8.0	12.0	7.0/MW-7

E-NOSES



E-NOSE S11



E-NOSE S13



E-NOSE S14



E-NOSE S15



E-NOSE S17



E-NOSE S20



E-NOSE S22



E-NOSE S23



E-NOSE S30



E-NOSE S35

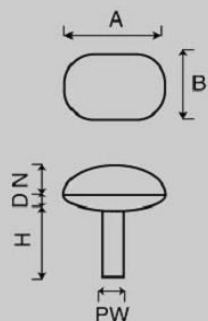

E-NOSE S	C	PW		A	B	C	PW	N	D	H
		NORMAL	SAND							
11.0	●	●	●	11.0	8.5	3.5/MW-3.5	3.5/SW-3	4.2		10.0
13.0		●		13.0	10.0		5.2/NWP-1	5.0		12.5
14.0		●	●	14.0	11.0		5.2/NWP-1	7.0		12.5
15.0		●		15.0	11.0		5.2/NWP-1	5.5		12.5
17.0	●	●		17.0	13.0	5.0/MW-5	5.2/NWP-1	9.0	3.0	13.0
20.0	●			20.0	15.0	6.5/MW-7		7.5		14.0
22.0	●			22.0	17.0	6.5/MW-7		12.0		15.0
23.0	●			23.0	18.0	5.0/MW-5		13.0	3.5	15.0
30.0	●			30.0	21.0	6.5/MW-7		10.5		14.0
35.0	●			35.0	25.0	6.5/MW-7		12.5		14.0

F-NOSES



F-NOSE S15



F-NOSE S18



F-NOSE S21

F-NOSE S	A	BC	N	H
15.0	15.0	5.0/MW-5	5.0	12.0
18.0	18.0	5.0/MW-5	5.5	10.0
21.0	21.0	5.0/MW-5	6.5	10.0

22 NOSE

ハナ 材質 PS

G-NOSES



G-NOSE S15



G-NOSE S18



G-NOSE S21



G-NOSE S25



G-NOSE S30



G-NOSE S40



G-NOSE S50

G-NOSE S	BC	PW	A	BC	PW	N	H
15.0	●	●	15.0	5.0/MW-5	5.0/NPW-1	7.5	12.0
18.0	●	●	18.0	5.0/MW-5	6.7/NPW-3or4	9.0	12.0
21.0	●		21.0	5.0/MW-5		10.5	12.0
25.0	●		25.0	5.0/MW-5		12.5	13.0
30.0	●		30.0	5.0/MW-5		15.0	14.0
40.0	●		40.0	6.5/MW-7		20.0	11.0
50.0	●		50.0	6.5/MW-7		25.0	13.0

H-NOSES



H-NOSE S13



H-NOSE S18

H-NOSE S	A	PW	N	H
13.0	13.0	5.0/NPW-1	3.5	12.0
18.0	18.0	5.0/NPW-1	4.0	12.0

J-NOSE



J-NOSE S30

J-NOSE S	A	BC	N	H
30.0	30.0	6.5/MW-7	11.5	15.0

WHISKER-NOSE



WHISKER-NOSE S22

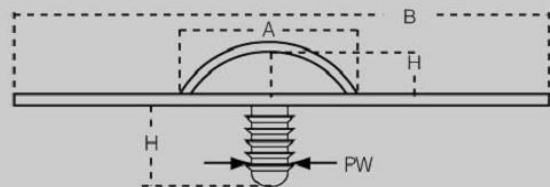

WHISKER	A	B	PW	N	H
22.0	21.0	87.0	6.5/NPW-3	8.0	13.0

MINI BEAR-NOSE



MINI BEAR-NOSE S7

MINI	A	C	N	H
7.0	6.5	3.5/MW-3.5	3.0	7.0

23 NOSE

ハナ 材質 PS

M-NOSES

M-NOSE S13

M-NOSE S16

M-NOSE S18

M-NOSE S21

M-NOSE S23

M-NOSE S25

M-NOSE S27

M-NOSE S30

M-NOSE S35

N-NOSE S	C	PW	A	C	PW	N	H
13.0		●	13.0		5.2/NPW-1	2.5	12.0
16.0		●	16.0		5.2/NPW-1	3.5	12.0
18.0	●		18.0	5.0/MW-5		6.5	12.0
21.0		●	21.0		6.7/NPW-3	4.5	13.0
23.0	●		23.0	5.0/MW-5		8.0	12.0
25.0		●	25.0		6.7/NPW-3	5.5	14.0
27.0		●	27.0		5.0/NPW-1	4.0	12.5
30.0	●		30.0	5.0/MW-5		10.0	12.0
35.0		●	35.0		5.0/NPW-1*2	4.0	12.5

※M-NOSE S35 两个足，所以使用两个垫圈。

BALL-NOSES

BALL-MOSE S7.5

BALL-MOSE S9

BALL-MOSE S10.5

BALL-MOSE S12

BALL-MOSE S15

BALL-MOSE S18

BALL-MOSE S21

BALL-MOSE S25

BALL-MOSE S30

BALL-MOSE S36

BALL	C	BC	PW	A	C/BC	PW	N	H
7.5	●			7.5	2.5/MW-1		6.0	7.5
9.0	●			9.0	2.6/MW-1		7.0	9.0
10.5	●			10.5	2.6/MW-1			
12.0		●	●	12.0	5.0/MW-5	5.0/NPW-1	8.0	12.0
15.0		●		15.0	5.0/MW-5		12.0	11.0
18.0		●		18.0	5.0/MW-5	6.5/APW-18	14.0	12.0
21.0		●		21.0	5.0/MW-5		15.0	12.0
25.0		●		25.0	6.5/MW-7		17.0	14.0
30.0		●		30.0	6.5/MW-7		21.0	14.0
36.0		●		36.0	6.5/MW-7		25.0	12.0

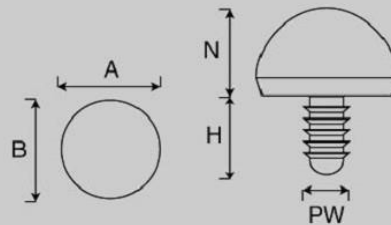

MR-NOSES



MR-NOSE D19

MR-NOSE	A	PW	N	H
19.0	19.0	6.5/NPW-3	19.0	13.5

24 NOSE

ハナ 材質 PS

HEART-NOSES

HEART	A	B	PW	N	H
13.0	13.0	11.5	5.0/NPW-1	5.0	13.5
18.0	18.0	16.5	6.7/NPW-3	6.0	13.0
21.0	19.5	21.0	6.7/NPW-3	6.0	13.0
38.0	36.5	38.0	6.5/NPW-4	12.0	13.0
44.0	44.0	30.0	6.5/HEART44	12.5	15.0
48.0	48.0	33.0	6.5/HEART48	11.0	15.0



HEART-NOSE S13



HEART-NOSE S18



HEART-NOSE S21



HEART-NOSE S38



HEART-NOSE S44



HEART-NOSE S48

KOALA-NOSES



KOALA-NOSE S13



KOALA-NOSE S16.5



KOALA-NOSE S21



KOALA-NOSE S24



KOALA-NOSE S30



KOALA-NOSE S36

KOALA	C	BC	PW	A	B	C/BC	PW	N	H
13.0	●			9.5	13.0	2.5/MW-1		4.0	6.5
16.5			●	11.5	16.5		5.0/NPW-1	5.0	12.0
21.0		●		14.0	21.0	5.0/MW-5		6.0	12.0
24.0		●		16.5	24.0	5.0/MW-5		7.0	12.0
30.0		●		20.0	30.0	6.5/MW-7		8.0	13.0
36.0		●		24.5	36.0	6.5/MW-7		10.0	13.0
42.0		●		29.3	42.0	6.5/MW-7		12.0	13.0
48.0		●		33.5	48.0	8.5/MW-8		14.0	13.0



KOALA-NOSE S42



KOALA-NOSE S48

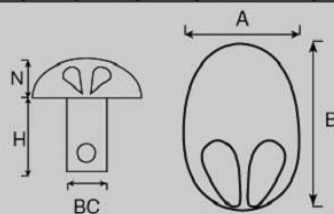

KOALA-PAWS 材質: PE



KOALA-PAWS S15



KOALA-PAWS S20



KOALA-PAWS S35



KOALA-PAWS S40

25 VISK EYES

ビスクアイ 材質 PMMA

GLASTIC & REALISTIC-HALFS



A	B	D
8.0	4.5	6.0
10.0	5.5	7.0
12.0	6.5	8.0
14.0	7.5	9.5
16.0	8.5	10.0
18.0	9.5	11.5
20.0	11.5	12.5
22.0	12.0	13.5
24.0	13.0	14.5
26.0	13.5	15.5

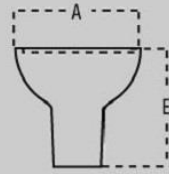
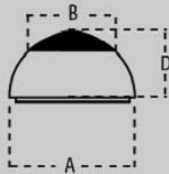

订货说明

例: VISK REALISTIC 26 BLUE
 产品类别 尺寸 颜色

GLASTIC & REALISTIC-CAPS



A	E
8.0	6.5
10.0	8.5
12.0	10.0
14.0	11.0
16.0	15.0
18.0	16.0
20.0	18.0
22.0	20.5
24.0	22.0
26.0	24.0

GLASTIC & REALISTIC



A	H
8.0	11.0
10.0	14.0
12.0	16.5
14.0	19.0
16.0	23.5
18.0	26.0
20.0	29.0
22.0	32.5
24.0	35.0
26.0	38.0

26 VISK EYES

ビスクアイ 材質 PMMA

VISK EYES CASES

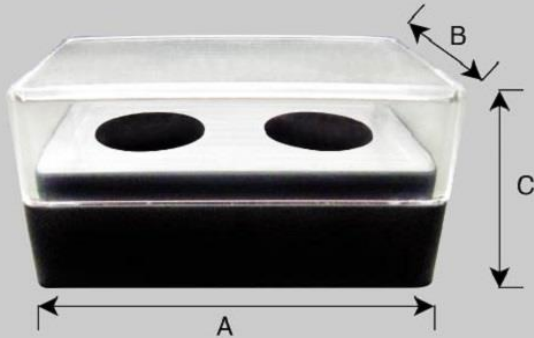

	A	B	C
8.0	42.0	22.0	14.0
10.0	42.0	22.0	18.5
12.0	42.0	22.0	21.0
14.0	42.0	22.0	23.5
16.0	58.5	33.5	28.0
18.0	58.5	33.5	30.0
20.0	58.5	33.5	33.5
22.0	73.5	43.5	43.5
24.0	73.5	43.5	43.5
26.0	73.5	43.5	43.5

GLASTIC EYES COLORS



REALISTIC EYES COLORS



颜色仅供参考，如客户所需颜色特殊可与我们协商。

27 SUCTION CUP

吸盤 材質 PVC

SYA



SYA-25-3-SB



SYA-25-3-CR



SYA-30-5-SB

SYA	SB	CR	A	B	C	D	E
25.0-3	●	●	25.0	3.0	7.0	6.0	8.0
30.0-5	●	●	30.0	5.0	8.0	7.0	9.0
35.0-5	●	●	35.0	5.0	9.0	9.5	11.5
35.0-6	●	●	35.0	6.0	10.2	9.5	10.0
40.0-6	●	●	40.0	6.0	10.5	9.5	12.0
45.0-6	●	●	45.0	6.0	11.0	12.0	11.0
55.0-7	●	●	55.0	7.0	15.0	13.0	13.0



SYA-30-5-CR



SYA-35-5-SB



SYA-35-5-CR



SYA-35-6-SB



SYA-35-6-CR



SYA-40-6-SB



SYA-40-6-CR



SYA-45-6-SB



SYA-45-6-CR



SYA-55-7-SB



SYA-55-7-CR

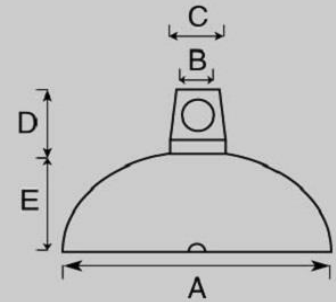

STY



STY-35-5-SB

STY-SB	A	B	C	D	E
35.0-5	35.0	5.0	10.5	10.0	10.0

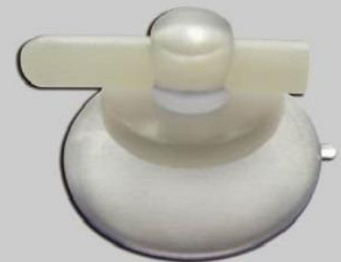

吸盘组合

订货说明

例: SUCTION CUP DC SYA 25 CR WHITE
 产品类别 材料 插孔 尺寸 光面 颜色

28 SUCTION CUP

吸盤 材質 PVC

SYM

SYM	SB	CR	A	B	C	D	E	F	G
10.0	●		10.0	5.0	2.3	2.0	1.0	4.0	3.0
10.0L		●	10.0	5.0	3.0	2.0	1.0	4.0	3.0
20.0	●	●	20.0	7.5	5.0	3.0	1.2	5.0	5.0
25.0	●		25.0	7.5	3.0	3.0	1.2	5.0	5.0
30.0	●		30.0	9.0	6.0	3.0	2.0	5.0	5.8
36.0	●		36.0	11.0	8.0	3.0	1.8	9.0	6.0
38.0	●		38.0	12.0	8.0	2.2	2.5	9.3	6.2
40.0	●		40.0	12.0	8.0	4.5	1.5	9.0	9.0
45.0	●		45.0	13.5	7.0	4.0	3.2	10.0	9.0
50.0	●		50.0	13.5	8.0	4.0	2.2	11.0	8.0
55.0	●		55.0	16.0	10.5	5.0	2.0	13.0	8.8
55.0		●	55.0	15.0	9.0	3.5	3.2	8.0	7.0



SYM-10-SB



SYM-10L-CR



SYM-20-SB



SYM-20-CR



SYM-25-SB



SYM-30-SB



SYM-36-SB



SYM-38-SB



SYM-40-SB



SYM-45-SB



SYM-50-SB



SYM-55-SB



SYM-55-CR



星型吸盘-35-SB

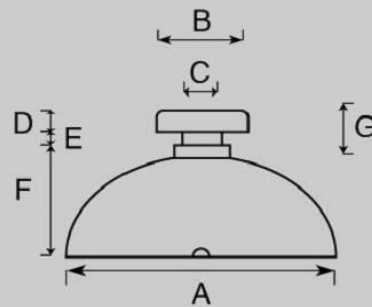

吸盘颜色可根据客户要求定做。

29 WASHER

ワッシャー 材質 PE

APW

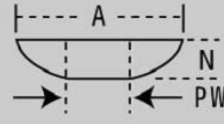

ANP	A	PW	N
7.0	7.0	2.9	2.0
7.0B	7.0	2.9	3.3
8.0	8.0	4.2	3.3
10.0	10.0	4.2	3.3
12.0	12.0	4.3	3.3
13.5	13.5	4.3	3.3
15.0	15.0	5.6	4.8
16.0	16.0	5.6	4.8
18.0	18.0	5.6	4.8
20.0	20.0	5.6	4.4
24.0	24.0	5.6	6.0
30.0	30.0	5.6	6.0

NPW

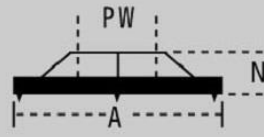

NPW	A	PW	N
No. 0	12.4	4.3	3.4
No. 1	13.8	4.3	3.4
No. 2	17.0	4.3	3.4
No. 3	17.0	5.8	3.6
No. 4	21.0	5.8	3.6

PW	A	PW	N
No. 5	27.0	5.8	3.6
No. 6	35.5	7.7	3.4
No. 6.5	35.5	5.7	3.5

PW



OPW

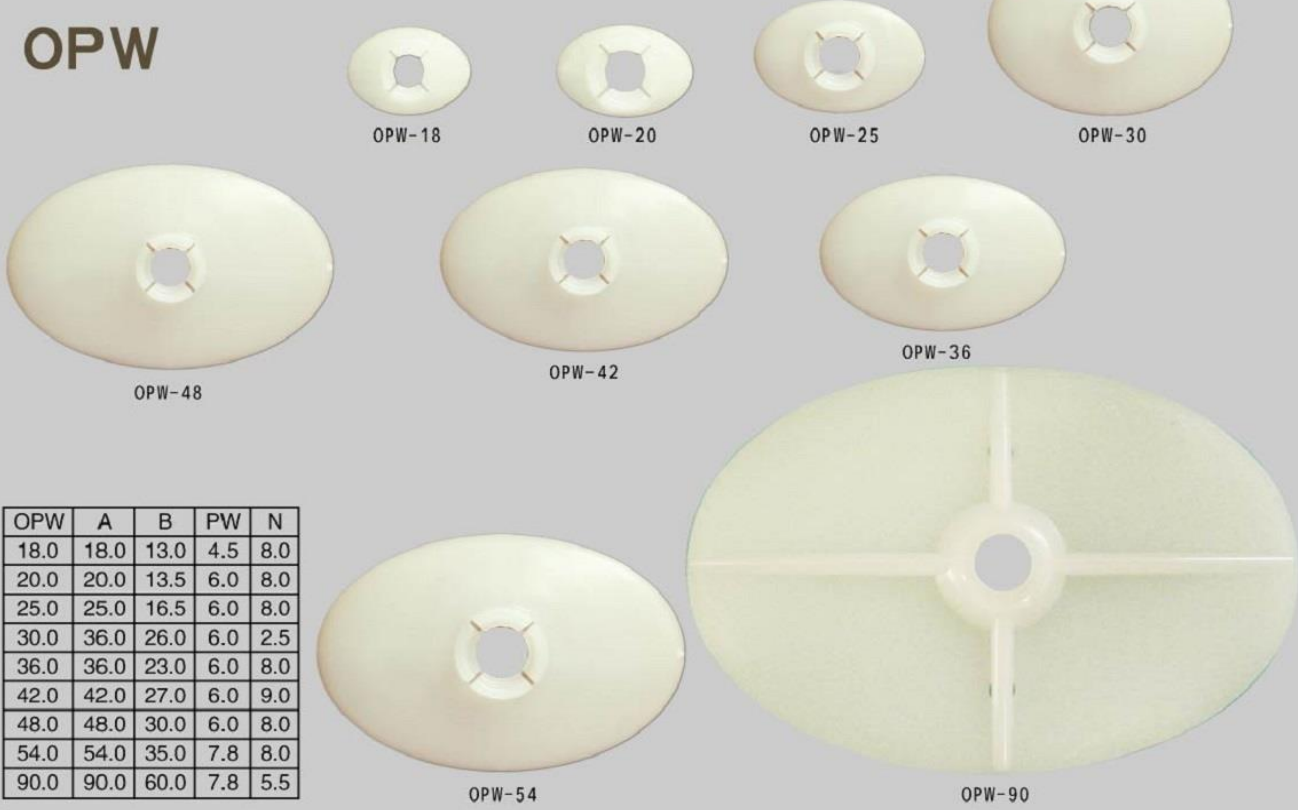

OPW	A	B	PW	N
18.0	18.0	13.0	4.5	8.0
20.0	20.0	13.5	6.0	8.0
25.0	25.0	16.5	6.0	8.0
30.0	36.0	26.0	6.0	2.5
36.0	36.0	23.0	6.0	8.0
42.0	42.0	27.0	6.0	9.0
48.0	48.0	30.0	6.0	8.0
54.0	54.0	35.0	7.8	8.0
90.0	90.0	60.0	7.8	5.5

30 WASHER

ワッシャー 材質 PE

PPW



PPW	A	PW	N
No. 0	13.0	4.2	2.5
No. 1	18.0	5.7	3.5
No. 2	24.5	5.7	4.0
No. 3	30.0	5.7	7.0
No. 4	35.5	5.7	8.0
No. 5	50.0	6.7	12.5



PPW No. 5

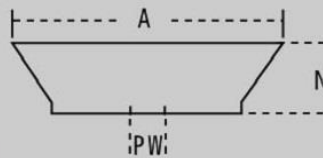

SPW	A	B	PW	N
10.0	10.0	7.0	2.7	3.6
13.0	13.0	9.5	4.2	3.6
16.0	16.0	9.5	4.2	3.6
22.0	22.0	12.0	5.7	3.6
40.0	40.0	17.5	5.7	4.8

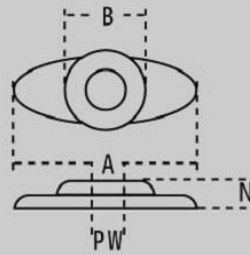

SSW	A	PW	N
No. 1	6.7	1.5	2.2
No. 2	6.3	2.0	2.2
No. 1.4	6.3	1.4	2.2
SW	A	PW	N
No. 1	10.0	1.8	2.3
No. 2	10.0	2.3	2.3
No. 3	10.0	2.8	2.3
CW	A	PW	N
No. 3	10.0	2.8	2.3

SPW



SSW

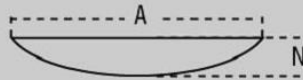

SW



HEART	A	B	PW
44.0	44.0	30.0	5.6
48.0	48.0	30.0	5.6

CW



CW No. 3

HEART



HEART-44

HEART-48

MW	A	C
No. 0	10.0	1.6
No. 1	11.0	2.2
No. 3	13.5	4.7
No. 3.5	13.5	3.0
No. 5	18.0	4.5
No. 7	23.0	6.0
No. 8	23.0	7.5

MW 铁质垫圈 材質: SUS



MW No. 0



MW No. 1



MW No. 3.5



MW No. 5



MW No. 7



MW No. 8

31 JOINT

ジョイント 材質 PP, PE

MALE 材質: PP



MALE S16



MALE S20



MALE S25



MALE S30



MALE S35



MALE S45



MALE S55

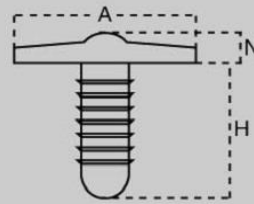

MALE S65

MALE S	A	N	PW	H	FEMALE
16.0	16.0	2.5	6.5/NPW-3	19.0	S 20
20.0	20.0	3.0	6.5/NPW-3	19.0	S 20
25.0	25.0	3.0	6.5/NPW-3	19.0	S 20
30.0	30.0	4.0	6.5/PW-5	21.0	S 30
35.0	35.0	4.0	6.5/PW-5	21.0	S 35
45.0	45.0	5.0	8.5/PW-6	25.0	S 45
55.0	55.0	5.0	8.5/PW-6	25.0	S 55
65.0	65.0	5.0	8.5/PW-6	25.0	S 65

FEMALE S	A	N	R
20.0	20.0	2.0	6.8
30.0	30.0	2.5	8.7
35.0	34.5	2.5	10.0
45.0	44.5	2.5	8.7
55.0	54.5	2.5	8.7
65.0	64.0	2.5	8.7

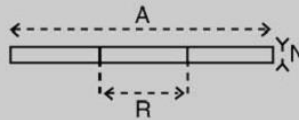

FEMALE 材質: PE



FEMALE S20



FEMALE S30



FEMALE S35



FEMALE S45



FEMALE S55

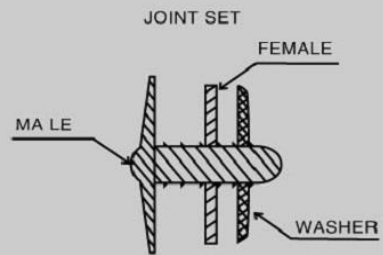

FEMALE S65

32 TOWEL HANGER

タオルハンガー

D-TYPE 材质: RING PS + SUCTION CUP 环保PVC + ADAPTER PE



O-TYPE 材质: PS

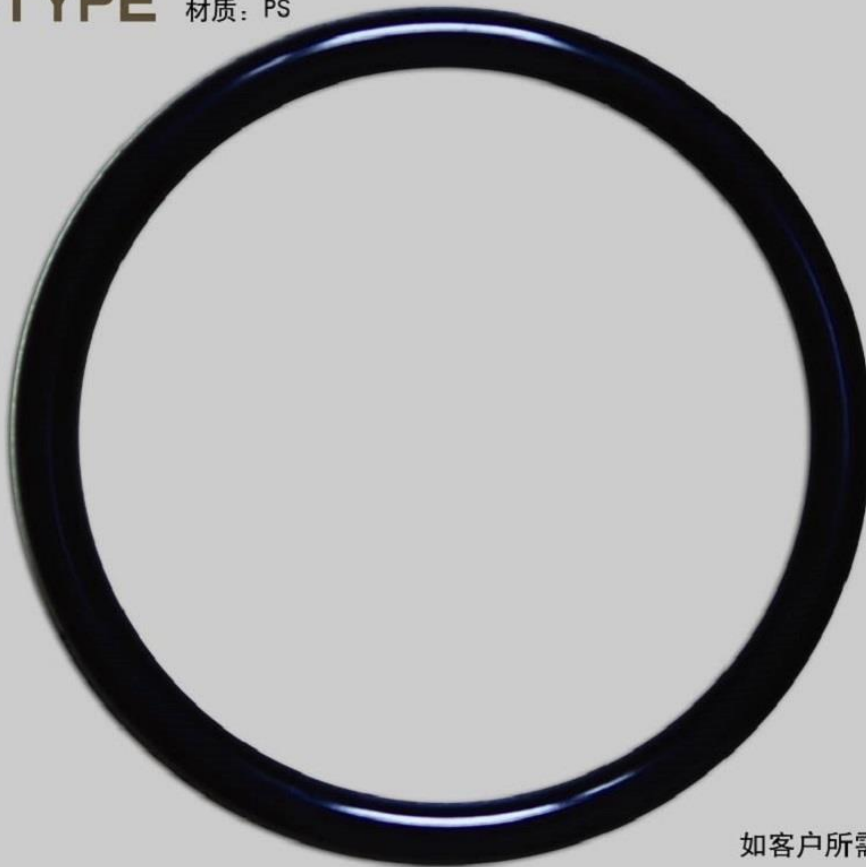









颜色仅供参考，
如客户所需颜色特殊可与我们协商。

LASER SIGHT

株式会社 ベルズワン

サイズ

							
3mm	3.5mm	4mm	4.5mm	4.8mm	5mm	5.2mm	6mm

		
6.5mm	7mm	8mm

		
ホログラム 無	ホログラム ゴールド	ホログラム シルバー

カラーバリエーション







※中目のカラー変更も受領ります。
※各カラーへのホログラム加工も御用意しております。

								
N.レッド	N.ブルー	N.イエロー	N.グリーン	N.ブラウン	N.LT.ブラウン	N.ピンク	アンバー	クリア

									
塗装 レッド	塗装 ブルー	塗装 イエロー	塗装 グリーン	塗装 ブラウン	塗装 ホワイト	塗装 ピンク	塗装 ゴールド	塗装 ブルーパール	塗装 イエローパール

※その他、上記以外の塗装カラーも御用意しております。

特殊タイプ

			
(1.5mm)	(1.75mm)	(2mm)	(2.25mm)
			
(2.4mm)	(2.5mm)	(2.6mm)	

(中目を好みの大きさに変えられます)

	
より目	三角目

※4.8mmのみ

材質:アクリル樹脂

→ 中目サイズ 特殊タイプ早見表

↓ 外形サイズ	1.5	1.75	2	2.25	2.4	2.5	2.6	3	3.25	3.5	4
3	◎										
3.5	○	◎									
4	○	○	◎								
4.5	○	○	○	◎							
4.8	○	○	○	○	◎						
5	○	○	○	○	○	◎					
5.2	○	○	○	○	○	○	◎				
6	○	○	○	○	○	○	○	◎			
6.5									◎		
7										○	◎
8											◎

※◎は標準の大きさ、○の大きさへ変更することが可能です。